



HYDRAULIC CUTTING EQUIPMENT

- Wire / Wire Rope / Nylon and Hemp Hawser / Conductor String
 - Cable / Power Cable / Umbilical Cable
- TO CUT:**
- Reactor Fuel Rods / Bar / Reinforcing Bar / Tube
 - Chain / Nuts / Bolts / Rivets / Pipe
 - Exhaust Systems / Tyre Bead
 - Structural Section / Plate / Nylon and Kevlar Rope



HYDRAULIC CUTTING EQUIPMENT

- Manufacturing / Mining / Construction and Demolition
- SUPPLIED TO:**
- Subsea Engineering, Exploration and Decommissioning
 - Offshore Oil & Gas Production, Exploration and Decommissioning
 - Nuclear Power Generation and Decommissioning

AUTHORISED DISTRIBUTOR:



... A CUT ABOVE THE REST



JAGTM

TM

TM

Hydraulic Cutting Equipment



JAGTM ... A CUT ABOVE THE REST

JAG™ Hydraulic Cutting Equipment: **End User Clients**



AEA Technology



bluewater



BRIDON

British Nuclear Group

CERTEX

**CURTISS
WRIGHT** Controls

ExxonMobil



Global Marine

HALLIBURTON

IR Ingersoll Rand

KCA DEUTAG

Malta Shipyards

NORTHROP GRUMMAN
DEFINING THE FUTURE

NUKEM



SUCO
INTERNATIONAL

Technip

Volker Stevin Marine

UKAEA



Hydraulic Cutting Equipment: **Contents**



Introduction

Page 4



Hydraulic Cutter Heads

Page 5



Hydraulic Cutter Units

Page 6



Hydraulic Guillotine Cutters

Page 7



Special Purpose Hydraulic Cutters

Page 8



Case Studies

Page 9

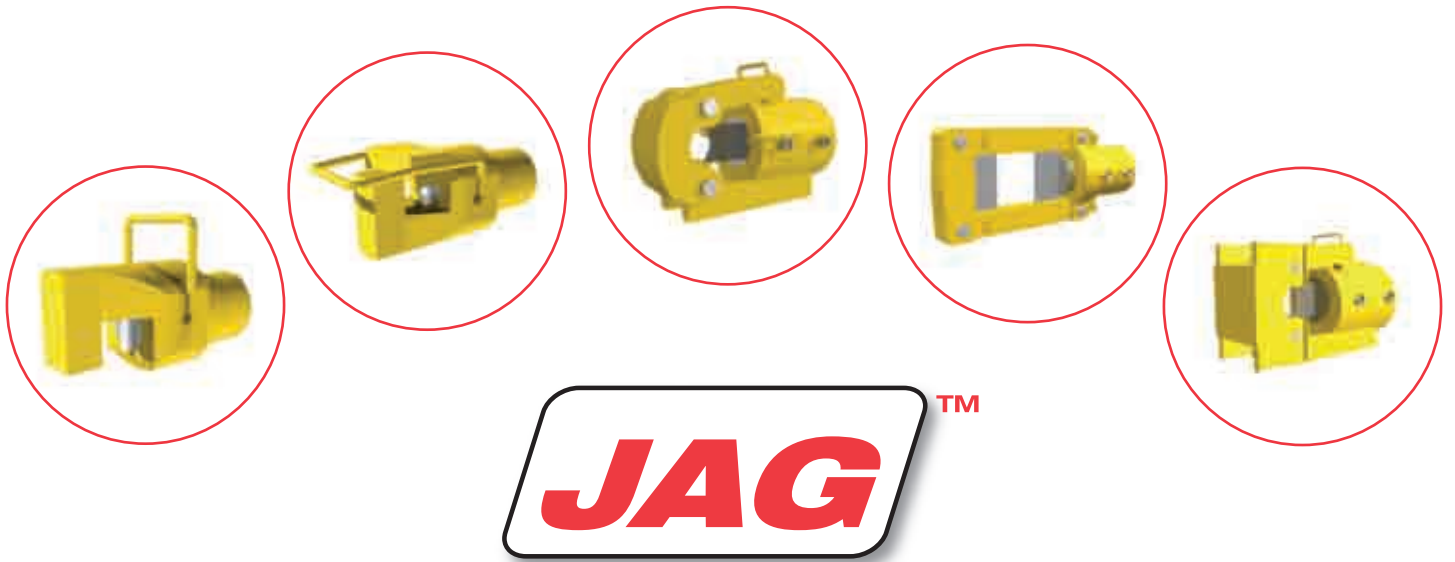

Hydraulic Cutting Equipment: Introduction

JAG Hydraulic Cutting Equipment has been designed and manufactured to excel in Safety, Quality, Durability and Ease of Use to ensure total customer satisfaction.

JAG is the UK's leading manufactured hydraulic Equipment Brand and has increased operator safety when working in hazardous environments by using enclosed moving parts and creating zero emissions when cutting. It has also increased productivity by using a fast non-jamming guillotine cutting action and a high pressure hydraulic system to give the ultimate cutting performance.

JAG Hydraulic Cutting Equipment has a proven track record within the following industries:

- Manufacturing / Mining / Construction and Demolition/ Recycling
- Offshore Oil and Gas Production, Exploration and Decommissioning
- Sub-sea Engineering Exploration and Decommissioning
- Nuclear Power Generation and Decommissioning

JAG Hydraulic Cutting Equipment can be used to cut the following materials:

- Wire/ Wire Rope/ Nylon and Hemp Hawser/ Conductor String
- Cable/ Power Cable/ Umbilical Cable
- Reactor Fuel Rods/ Bar/ Reinforcing Bar/ Tube
- Chain/ Nuts/ Bolts/ Rivets/ Pipe
- Exhaust Systems/ Tyre Bead
- Structural Section/ Plate/ Nylon and Kevlar Rope

Plus a broad range of associate materials which are also within the equipment's cutting capacities.

JAG Hydraulic Cutting Equipment has been specifically engineered to meet the toughest production requirements and is ideally suited to operate in intense production applications. All equipment is designed to operate up to a maximum working pressure of 10,000 psi and is manufactured to meet with CE specifications.

JAG Hydraulic Cutter Heads are designed as compact cutters for close up precision cutting operations with single acting cylinders for simple operation. The straight edged double bladed cutting system helps to maximize the power to weight ratio for cutting:

- Chain / Wire / Reinforcing Bar and Tyre Bead

The cutting equipment is designed with a built in 4:1 safety factor and is manufactured to a rigorous quality procedure, proof tested and certified to meet with current CE specifications. All the cutting equipment is designed to operate up to a maximum working pressure of 10,000 PSI. The cutting equipment has a proven track record within:

- Manufacturing / Mining / Recycling / Construction and Demolition
- Offshore Sub-sea Engineering / Oil /Gas production, exploration and decommissioning

JAG Hydraulic Cutter Heads are high performance, reliable and robust production equipment, and offer a no nonsense ready to operate production package when combined with the **SPX Power Team** range of products, to give the ultimate cutting package.

- Smooth guillotine action reduces risk of jamming
- Minimum operator effort when using powered pump
- Lightweight tools permit use anywhere
- Operator guarding
- Safe and easy to operate
- All models cut a wide variety of materials
- No set up time required
- All models fitted with high flow couplers
- Easily replaceable blades
- Single acting operation
- Manufactured in UK



Selection Chart					
Model No.	Output (Tons)	Weight (Kgs)	Length (mm)	Width (mm)	Height (mm)
HCH 15	15	10	235	95	100
HCH 25	25	16	235	110	120
HCH 70	70	23	440	180	180
HCH 100	100	40	460	410	250
HCH 140	140	72	635	565	345

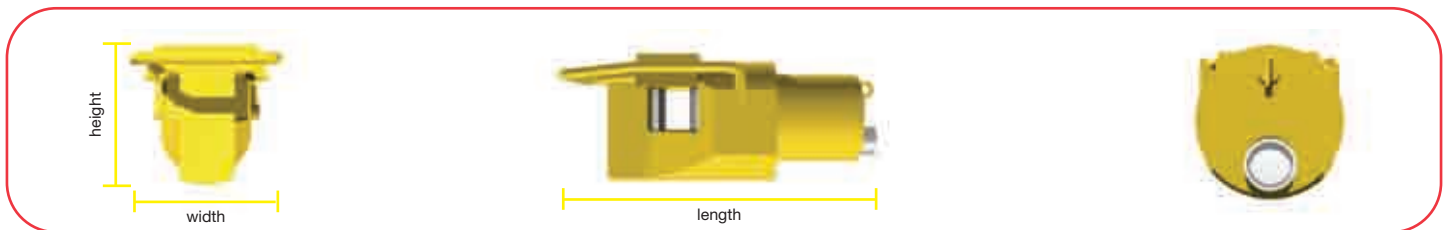
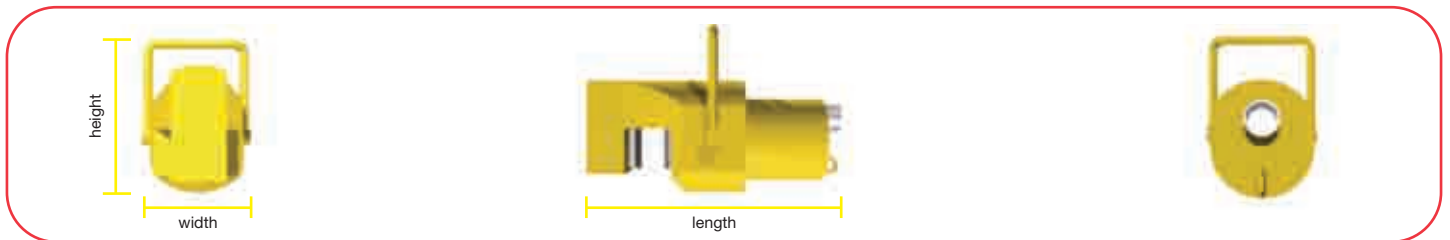

Cutting Performance			
Model No.	Maximum Cutting Capacity (mm)		
	Tyre Bead	Reinforcing Bar	Chain
HCH 15	Car	15	15
HCH 25	Van	20	20
HCH 70	PSV / HGV	26	26
HCH 100	Agricultural	34	34
HCH 140	Earth Moving	50	50

JAG Hydraulic Cutter Units are designed for remote cutting operations with double acting cylinders and a concaved edged single blade cutting system to ensure a clean and full cut of the finest and toughest:

- Wire / Rope / Cable / Reinforcing Bar and Tube

The cutting equipment is designed with a built in 4:1 safety factor and is manufactured to a rigorous quality procedure, proof tested and certified to meet with current CE specifications. All the cutting equipment is designed to operate up to a maximum working pressure of 10,000 PSI. The cutting equipment has a proven track record within:

- Manufacturing / Mining / Recycling / Construction and Demolition
- Offshore Sub-sea Engineering / Oil / Gas production, exploration and decommissioning
- Nuclear Power Generation and Decommissioning

JAG Hydraulic Cutter Units are high performance, reliable and robust production equipment, and offer a no nonsense ready to operate production package when combined with the **SPX Power Team** range of products, to give the ultimate cutting package.

- Smooth guillotine action reduces risk of jamming
- Minimum operator effort when using powered pump
- Double acting operation
- Safe and easy to operate
- All models cut a wide variety of materials
- No set up time required
- All models fitted with high flow couplers
- Easily replaceable blades
- Cutter suitable for remote operation
- Manufactured in UK



Selection Chart

Model No.	Output (Tons)	Weight (Kgs)	Length (mm)	Width (mm)	Height (mm)
HCU 38	36	30	400	155	270
HCU 63	80	70	450	200	390
HCU 90	80	80	515	200	390
HCU 114	120	140	570	280	445

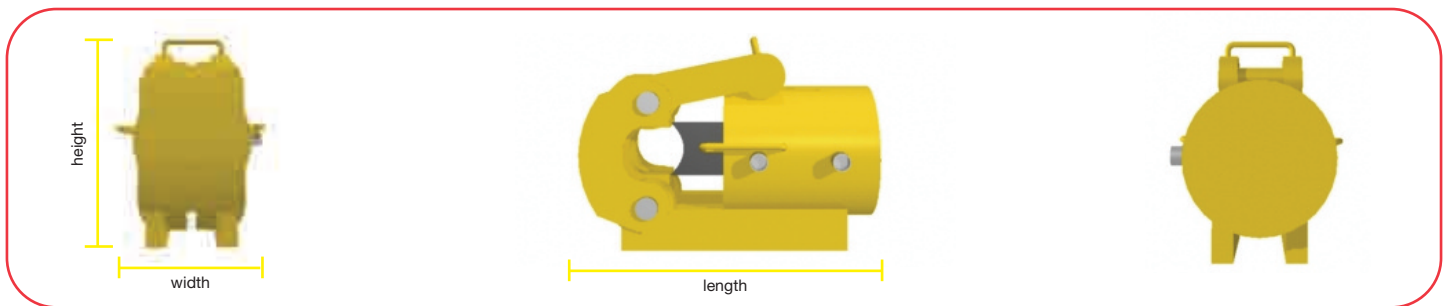

Cutting Performance

Model No.	Maximum Cutting Capacity (mm)			
	Wire Rope	Cable	Reinforcing bar	Tube
HCU 38	38	38	20	38
HCU 63	63	63	32	63
HCU 90	90	90	32	90
HCU 114	114	114	40	114



Hydraulic Cutting Equipment: Guillotine Cutters

JAG Hydraulic Guillotine Cutters are designed for remote cutting operations with double acting cylinders and a straight edged double bladed cutting system to maximize the cutting force to cut:

- **Power Cable / Structural Section**

The cutting equipment is designed with a built in 4:1 safety factor and is manufactured to a rigorous quality procedure, proof tested and certified to meet with current CE specifications. All the cutting equipment is designed to operate up to a maximum working pressure of 10,000 PSI. The cutting equipment has a proven track record within:

- Construction and Demolition / Mining / Recycling
- Offshore Sub-sea Engineering / Oil / Gas Production, Exploration and Decommissioning
- Nuclear Power Generation and Decommissioning

JAG Hydraulic Guillotine Cutters are high performance, reliable and robust production equipment, and offer a no nonsense ready to operate production package when combined with the **SPX Power Team** range of products, to give the ultimate cutting package.

- Smooth guillotine action reduces risk of jamming
- Minimum operator effort when using powered pump
- Double acting operation
- Safe and easy to operate
- All models fitted with lifting eyes
- No set up time required
- All models fitted with high flow couplers
- Easily replaceable blades
- Cutter suitable for remote operation
- Manufactured in UK

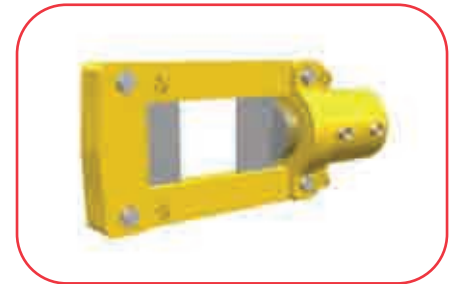

Selection Chart					
Model No.	Output (Tons)	Weight (Kgs)	Length (mm)	Width (mm)	Height (mm)
HGC 100	60	70	715	150	260
HGC 150	120	190	864	190	335
HGC 200	180	300	1020	220	420

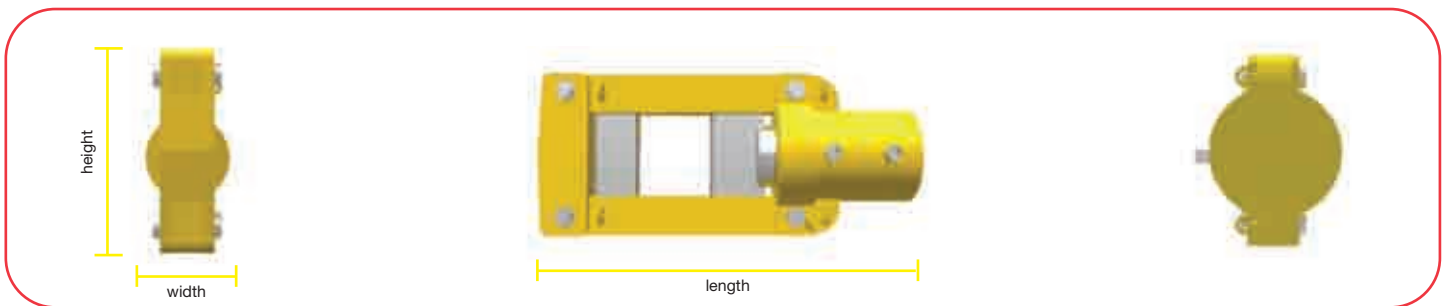

Cutting Performance		
Model No.	Maximum Cutting Capacity (mm)	
	Structural Section	Power Cable
HGC 100	100 X 50	100
HGC 150	150 X 125	150
HGC 200	200 X 150	200

JAG Special Purpose Hydraulic Cutters are uniquely designed and individually manufactured to meet specific production requirements including:

- Manual, remote or robotic control
- Vertical or horizontal operating positions
- Protection to suit the operating environment with an epoxy paint finish for radioactive, offshore open air applications and a nickel plate finish for offshore sub-sea applications.
- Single or double acting cylinder configurations with a high tonnage option for low pressure hydraulic system applications.

JAG Special Purpose Hydraulic Cutters are designed with a built in 4:1 safety factor and are manufactured to a rigorous quality procedure, proof tested and certified to meet with current CE specifications and are designed to operate up to a maximum working pressure of 10,000 PSI.

The cutting equipment can incorporate hydraulically operating jaws and latches, roller guide systems, guide shute systems, guarding systems and mobile work stations. All the equipment incorporates an easy replaceable blade system and specialised seal kit variations such as polyurethane seals for use with hydraulic fluids, viton seals for use with water glycol fluids and EPR seals for use with fire resistant fluids. The cutting equipment has a proven track record within:

- Offshore Sub-sea Engineering / recycling
- Offshore Oil / Gas Production, Exporation and Decommissioning
- Nuclear Power Generation and Decommissioning

JAG Special Purpose Hydraulic Cutters are high performance, reliable and robust production equipment, and offer a no nonsense ready to operate production package when combined with the **SPX Power Team** range of products, to give the ultimate cutting package.

- Smooth guillotine action reduces risk of jamming
- Minimum operator effort when using powered pump
- Single & Double acting operation
- Safe and easy to operate
- All models cut a variety of materials
- No set up time required
- All models fitted with high flow couplers
- Easily replaceable blades
- Cutter suitable for remote operation
- Manufactured in UK

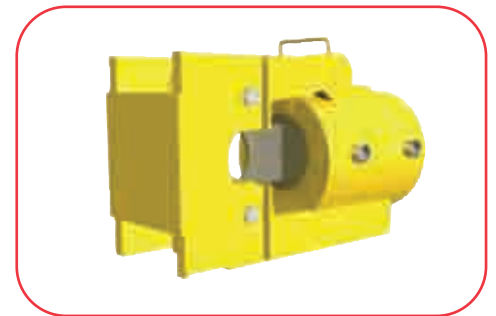

Selection Chart

Model No.	Output (Tons)	Weight (Kgs)	Length (mm)	Width (mm)	Height (mm)
SPHCU 150	220	460	900	420	570
SPHCU 200	400	880	1100	540	780

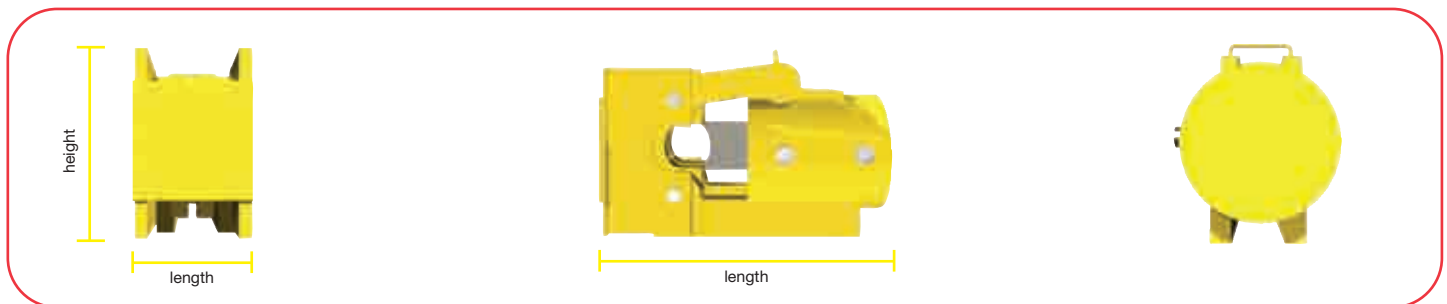

Cutting Performance

Model No.	Maximum Cutting Capacity (mm)			
	Wire Rope	Cable	Reinforcing bar	Tube
SPHCU 150	150	150	54	150
SPHCU 200	200	200	72	200

Special purpose cutter specification A

- Hydraulically operated jaw mechanism
- Roller guide system
- Epoxy paint finish
- Concaved cutting blade
- Vertical mounting bracket
- Cutter suitable for remote operation

Manufactured for **General Electric Company**

This cutter was designed to cut 200mm diameter Nylon Hawser Cord as part of an emergency cut off system on an offshore satellite refuelling station.



Special purpose cutter specification B

- Lockable latch arrangement
- Mounting feet
- Viton seals for use with water glycol
- Epoxy paint finish
- Concaved cutting blade
- Cutter suitable for remote operation

Manufactured for **Atomic Energy Authority**

This cutter was designed to cut 200mm diameter Spent Nuclear Fuel Rods in a Radioactive Cell.

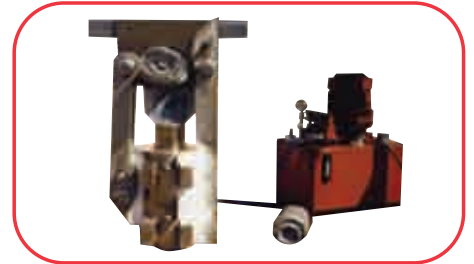

Special purpose cutter specification C

- Mobile bogie unit
- Rope guide mechanism
- Quick release jaw pins
- Concaved cutting blade

Manufactured for **Exxon Oil Company**

This cutter was designed to cut 140mm diameter High Tensile Wire Rope and was used as part of the construction equipment on the World's first 'guyed' Oil platform.

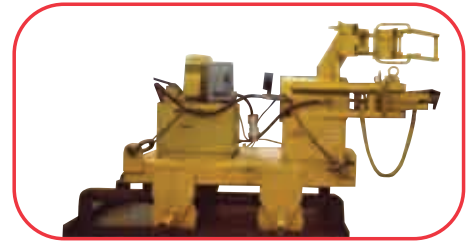

Special purpose cutter specification D

- Mobile work station
- Epoxy paint finish
- Mounting base

Manufactured for **Cable and Wireless Marine**

Manufactured for **Dunlop Coflexip**

This cutter was designed to cut 90mm diameter Spent Umbilical Cable for use in a cable recycling workshop.



Special purpose cutter specification E

- Mobile work station
- Mounting base
- Heavy duty lifting bracket
- Straight edged cutting blade

Manufactured for **Bridon Ropes**

This cutter was designed to cut 140mm diameter High Tensile Wire Rope for use in different areas of a ropery shop.



Special purpose cutter specification F

- Hydraulically operated safety latch mechanism
- Hydraulically operated locking pin
- Epoxy paint finish
- Straight edged cutting blade
- Cutter suitable for remote operation

Manufactured for **Atomic Energy Authority**

This cutter was designed to cut 200mm diameter Spent nuclear Fuel Rods and was loaded and operated by a robotic system.



Special purpose cutter specification G

- Feeder and waste chute system
- Concaved cutting blade
- High tonnage unit for use with low pressure system
- Fixed jaw assembly
- Mounting plate
- Cutter suitable for remote operation

Manufactured for **British Nuclear Fuels**

This cutter was designed to cut 50mm diameter Radioactive Stainless Steel Bar on a Nuclear site performing decommissioning work.

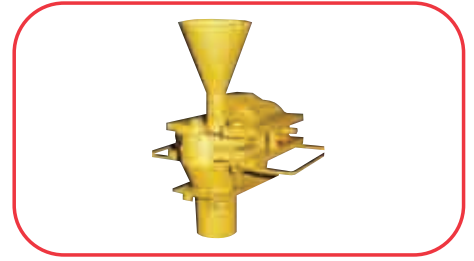

Special purpose cutter specification H

- Rope guide system
- Epoxy paint finish
- Fixed jaw assembly
- Anchor bracket
- Cutter suitable for remote operation

Manufactured for **European Marine Contractors**

This cutter was designed to cut 63mm diameter High Tensile Wire Rope while operating Sub-sea.

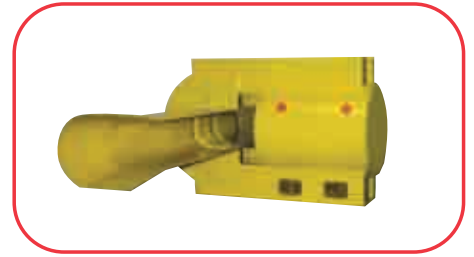

Special purpose cutter specification I

- Fixed jaw assembly
- Rope guide system
- High tonnage unit for use with low pressure system
- Quick release jaw pins
- Nickel plate finish
- Anchor bracket
- Cutter suitable for remote operation

Manufactured for **Norwegian Offshore Oil Industry**

This cutter was designed to cut 90mm diameter High Tensile Wire Rope as part of an emergency cut off system on an Oil Platform.

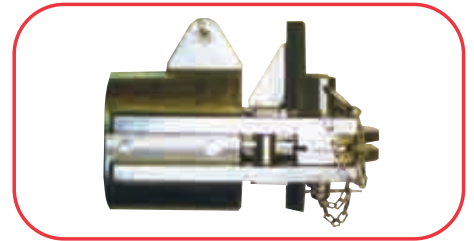

Special purpose cutter specification J

- Angled blade for loading access
- Lifting bracket
- Epoxy paint finish
- External mounting points
- Cutter suitable for remote operation

Manufactured for **Atomic Weapons Establishment**

This cutter was designed to cut 200mm diameter Spent Nuclear Reactor components during decommissioning work in a Reactor Hall.



Special purpose cutter specification K

- Hydraulically operated safety latch mechanism
- Concaved cutting blade
- Fixed jaw assembly
- Epoxy paint finish
- External mounting points
- Cutter suitable for remote operation

Manufactured for **British Nuclear Fuels**

This cutter was designed to cut 50mm diameter Radioactive Reactor components while operating in a Reactor Cooling Pond.



Special purpose cutter specification L

- Fixed anvil
- Vertical mounting base
- Epoxy paint finish
- Double acting operation
- Cutter suitable for remote operation

Manufactured for **Volker Stevin Marine**

This cutter was designed to cut 200mm diameter Power Cable as part of an emergency cut off system onboard a Cabling Vessel.



Special purpose cutter specification M

- Rope clamp assembly
- Epoxy paint finish
- Concaved cutting blade
- Fixed latch assembly
- Cutter suitable for remote operation

Manufactured for **Haliburton**

These cutters were designed to cut 90mm diameter High Tensile Wire Rope to form part of a Sub-sea Salvage Package.

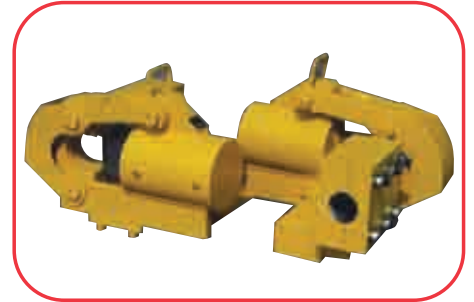

Special purpose cutter specification N

- Bolt in collar assembly
- Quick release latch pin
- Lifting frame
- Fixed latch assembly
- Cutter suitable for remote operation

Manufactured for **Soco**

This cutter was designed to cut 150mm diameter High Tensile Wire Rope as an Emergency Mooring cut off system onboard a Super Tanker.



Special purpose cutter specification P

- Multiple mounting holes
- Internal intensifier
- Epoxy paint finish
- Manufactured from anti corrosive materials
- High phosphate nickel plating
- Fixed latch assembly

Manufactured for **Curtiss Wright Controls**

These cutters were designed to cut 50mm diameter High Tensile Titanium as part of an Emergency Cut off System onboard Nuclear Powered Submarines.

